

Busbar 600 A with cover

www.victronenergy.com

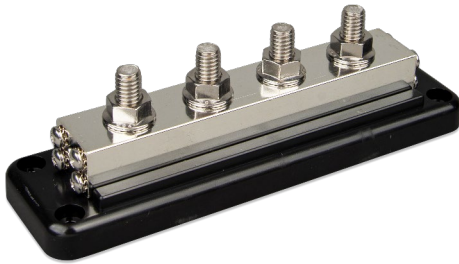

Busbar 600 A with 4 high current terminals and 8 low current screw terminals, without cover

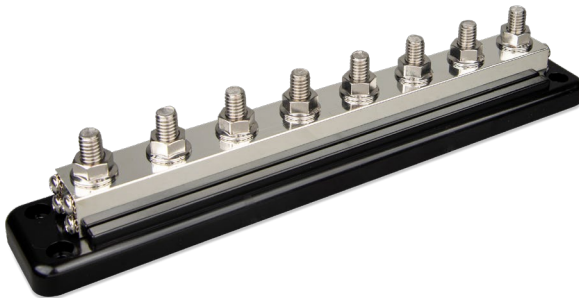

Busbar 600 A with 8 high current terminals and 8 low current screw terminals, without cover

Busbar 600 A with cover	
Max. current	600 A
Max. Voltage	70 VDC
Terminal diameter	3/8 inch / 9.53 mm
Terminal height	0.76 inch / 19 mm
Terminal material	Stainless steel
Flange nut material	Stainless steel
Recommended torque	180 lbf-inch / 20 N·m
Screw terminals	diameter #8 (0.164 inch) / 4.2 mm
Screw material	Stainless steel
Recommended torque	17 lbf-inch / 2 N·m
Busbar material	Tin-plated copper (19 x 24 mm)
Base material	ABS, black, UL 94 V-0
Cover material	ABS, black, UL 94 V-2
Weight, 4 terminals	1.7 lb / 0.75 kg
Dimensions (hxwxh) (with cover)	2.6 x 8.5 x 3.4 inch 65 x 216 x 86 mm
Weight, 6 terminals	2.9 lb / 1.3 kg
Dimensions (hxwxh) (with cover)	2.6 x 12.9 x 3.4 inch 65 x 327 x 86 mm



Cover

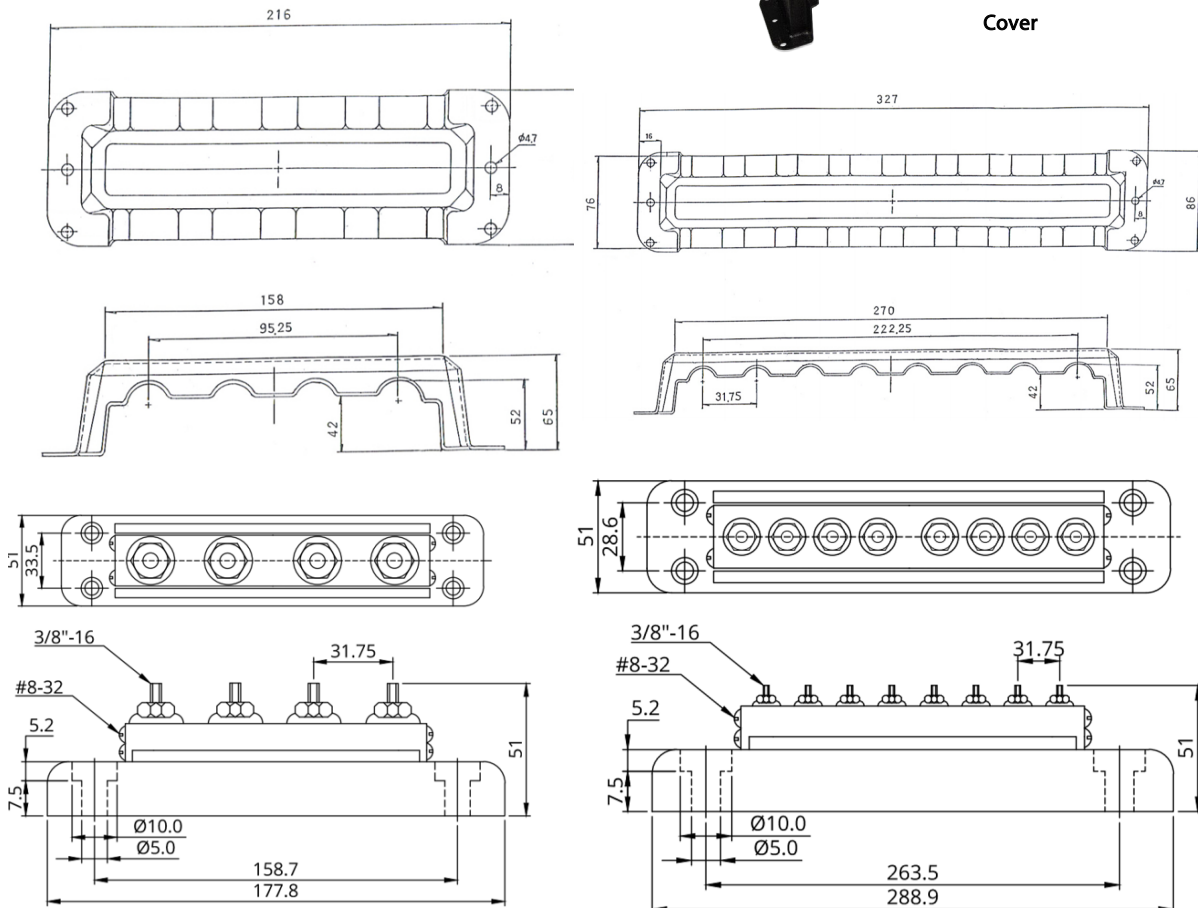

Drawings are not to scale