



Version1.0

NEMO2000

INSTRUCTION MANUAL

24V / 48V Marine Grade Wind Turbine



Serial number: _____

Please read and understand this manual completely before operating the machine.

Contents

1. Getting started	1
2. Safety instruction	1
3. Installation siting	3
4. Specifications	4
5. Part name	5
6. Assembling module	5
6-1 Verify the following upon purchase	5
6-2 Assembly procedure	6
6-3 Attaching to pole	7
7. Connecting the system	8
7-1 Before connecting	8
7-2 Length of the extension cable that leads from the wind generator to the battery	8
7-3 D.P.D.T. (Double pole double throw) blade switch	8
7-4 Connecting the wind generator output cable extension	9
7-5 Connection example	9
7-6 Connecting the System	10
8. Explanation Operations	10
9. Considerations when choosing peripheral materials/Device	11
9-1 Batteries	11
9-2 Mounting tower	12
9-3 Cable Diameter size	13
9-4 Inverters	13
9-5 Grounding	14
10. Site Elevation	14
11. Maintaining the generator system	15
12. Troubleshooting	16
13. Warranty information	18

1. Getting Started

Congratulations on the purchase of your new 2000W–24V/48V Shoot Power Wind Turbine. This manual will provide you with a good basic understanding of the operation and maintenance of this unit. If you have any questions regarding the operation and/or maintenance of the unit, please consult your point of purchase or contact us at:



www.shootpower.com
Email: info@shootpower.com

In the unlikely event that this product does not function properly, prohibit all persons except for trained technicians from handling its internal systems and contact either the dealer from whom you purchased it or Shoot Power customer service department: info@shootpower.com

- ◆ The specifications of this product may change due to improvements without prior notice.
- ◆ For explanation purposes, the illustrations and images throughout this manual may differ from the actual product.
- Certain installation procedures are dangerous. Always ask a trained professional to perform the installation work.
- Be aware that manufacturer assumes no responsibility for accidents or damage caused by improper installation, use, or attempts to modify this product.
- Be aware that the manufacturer assumes no responsibility for accidents or damage sustained as a result of not following the procedures and warnings specified in this manual.
- ⚠ Failure to operate this product in accordance with the content of sections labeled “Danger”, “Warning”, and “Caution” may result in accidental death, injury, fire and/or damage to the product itself.

2. Safety instruction

Particularly important information is distinguished in this manual by the following notations.

Safety information is indicated as shown below.



This symbol indicates information that could result in death or severe injury if ignored. It is used to indicate information of a particularly dangerous and/or urgent nature.



This symbol indicates information that could result in death or severe injury if ignored.

 **CAUTION** //

This symbol indicates information that could result in death, severe injury, or damage to limited property if ignored.

Be aware that failure to use the product in the manner indicated by  **CAUTION** may, depending on circumstances, also have severe consequences. All of the symbols described above indicate important safety information. Obey all safety information when using this product.

Safety information is indicated as shown below.



This symbol is intended to draw reader's attention to Danger/Warning/Caution information. Specific details on the nature of the threat to safety are indicated inside or beside the symbol.



This symbol indicates prohibited actions. Specific details on the prohibited action are indicated inside or beside the symbol.



This symbol indicates instruction that must be followed. Specific details on the mandatory instructions are indicated inside or beside the symbol.

 **DANGER** //



For safety reasons, do not install the wind generator before inspecting the durability/quality of the pole and the area in which it will be installed. If the pole and the location are not suitable, injury or death may result.



Install this product so that the tips of the rotor blades have at least 3.5m (11.5 ft) clearance from any surrounding objects. After installation is complete, clear away all scaffoldings, making sure that the rotor blades are far out of reach of people, pets and/or livestock.



Never touch a moving rotor blade by your hand or any other part of the body. The rotor blades are sharp and accidental contact can result in death or severe injury.



The body of wind generator will also move in accordance with wind direction once it begins to make contact with the wind. Exercise caution if it is necessary to approach the wind generator to perform installation or maintenance work.

 **WARNING** //



Do not install the wind generator in close proximity to electric or telephone lines. A fallen pole or contact between the rotor and electric/telephone lines could result in electrocution, disconnection, damage or malfunction of the turbine.



Do not install the wind generator in close proximity to structures such as smokestacks that attain extremely high temperatures. The heat could melt the insulation on electrical cables, resulting in electrocution, fire or other damage.



Do not install the wind generator if the pole to which it will be attached is not standing straight up. The wind generator could fall, causing an accident or mechanical damage/malfunction.



Do not use the wind generator for any purpose other than generating electricity from natural wind. Do not attempt to generate electricity by mounting the wind generator on a moving vehicle. Do not use the wind generator in close proximity to an exhaust duct or in any other extremely high-temperature environment. Doing so could result in fire, injury, or damage to the wind generator.



Discontinue use if the lines or cables are damaged (i.e. exposed wires, cut cables, plug damage). Continued use could result in electrocution, fire, or short circuits.



Do not pull on, excessively bend, or attempt to modify the wires/cables of the wind generator. Doing so could result in cord damage, electrocution, or fire.



Never attempt to disassemble or modify the wind generator. Doing so could result in electrocution, fire, or wind generator malfunction.



Due to conditions of use, this system may not continuously supply stable electrical power. Do not attempt to use the electricity generated by the wind generator to power medical devices or other equipment related to human life systems support. Do not attempt to use the electricity generated by the wind generator to power personal computers not equipped with batteries or other auxiliary power sources.

CAUTION



Observe all safety precautions when working on the wind generator in high locations. Take care to ensure that hardware and other parts do not fall from the wind generator. Falling parts can cause injuries or other accidents.



Before assembling the wind generator, secure adequate space to ensure that work can be completed safely. Inadequate space can result in injuries or other accidents.

3. Installation siting

Small changes in wind speed can have a dramatic effect on power production. The location of your wind turbine should be carefully considered.

Each installation is different and is often a compromise between tower height, distance from the battery bank, local zoning requirements and obstacles such as buildings and trees.

In general the higher the tower the greater the wind speed and ultimately the power production. However, towers are expensive and can easily exceed the cost of the turbine.

The minimum recommended tower height is 25 ft (7.6 m) on open ground or 20 ft (6m) above nearby obstructions. Try to locate the wind turbine in the “cleanest” turbulent free air as possible. Turbulence will reduce the efficiency of the wind turbine and may accelerate wear on rotating components.

Safety must be the primary concerned when selecting the mounting location. Install wind turbine so there is no possibility of accidental contact with rotating blades even if it requires installing the wind turbine in a less than ideal location. Safety has precedence over efficiency.

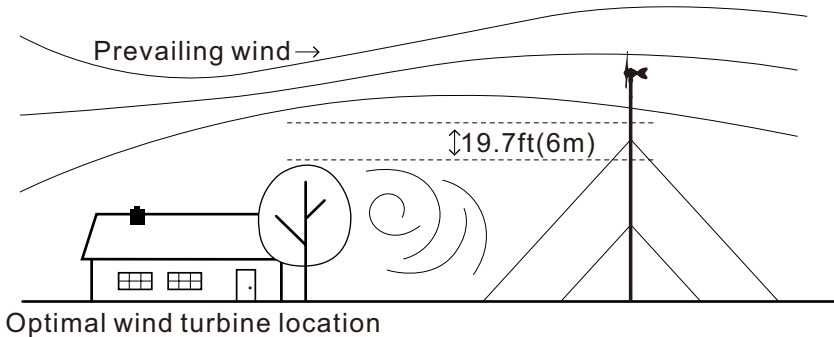

4. Specifications

Wind Turbine Type	Horizontal axis, up-wind
UPC code	839290007075
Rotor Diameter	1776mm(69.9")
Weight	18kg(38lbs)
Mount Diameter	48.6mm(1-15/16")
Number Blades	3
Blade Material	Carbon-fiber
Blade Mass (per piece)	532g
Body Material	Aluminum diecast
Product Finish	Telfon-based paint
Generator	Synchronous-type, three phase power generator with neodymium iron boron magnets
Controller	Built-in
Yaw control	Free yaw (360 degrees)
Direction Control	Swing-tail
Over Wind Control	Stall control(600rpm mode)
Start-up wind speed	3m/s(11KPH, 6.7MPH)
Cut-out wind speed	20m/s(72KPH, 45MPH)
Survival wind speed	49.2m/s(177KPH, 110MPH)
Rated Power	1KW (12.5m/s, 45KPH, 28MPH)
Rated Rotor Speed	1000rpm
Maximum Power	2KW (20m/s, 72KPH, 45MPH)
Maximum Rotor Speed	1000rpm(20m/s, 72KPH, 45MPH)
Output Voltage	DC25V or DC50V
Braking System	Regenerative electromagnetic braking system
Communication System	Remote monitor(Optional accessory)
Recommended System	Off-grid: deep cycle lead acid battery, 420Ah or more

Power output(W) Output power characteristics

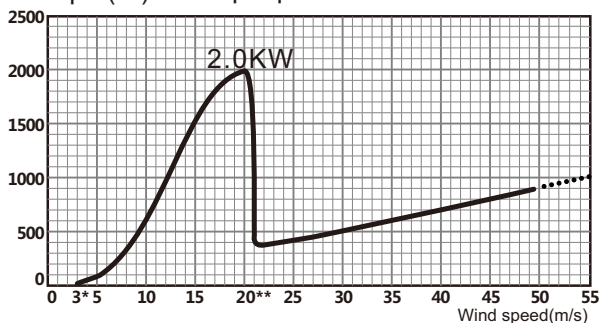

*Cut-in: wind speed at which the turbine begins to produce power.

**Cut-out: wind speed at which the turbine stops to produce power.

5.Part name

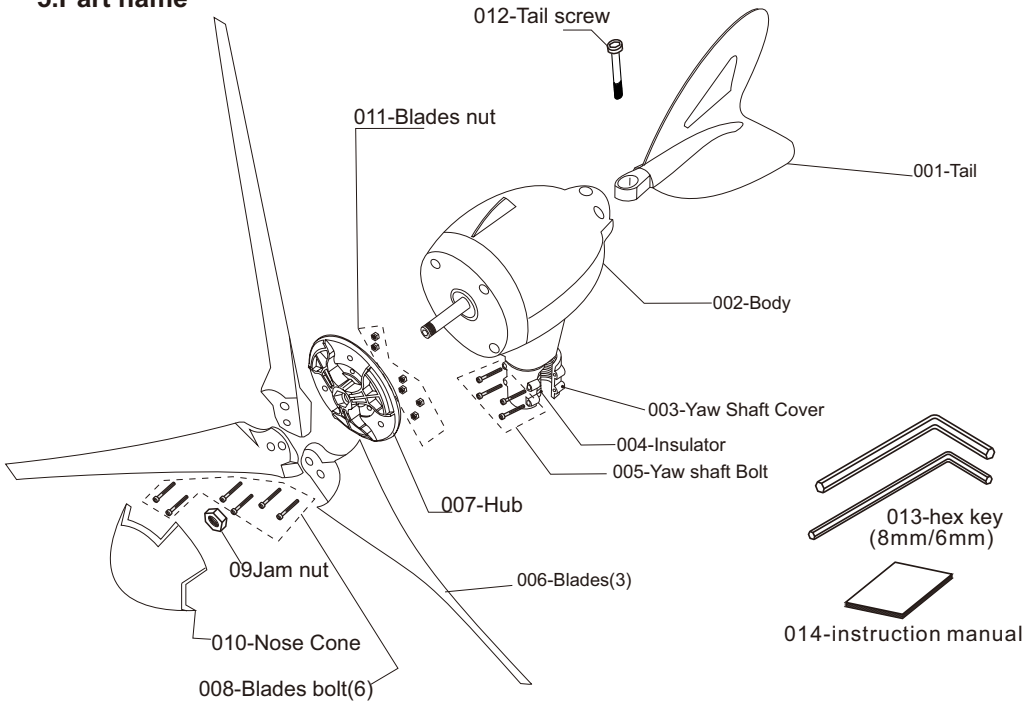

Item No.	Name	Qty	Item No.	Name	Qty
001	tail	1	009	Jam nut	1
002	Body	1	010	Nose cone	1
003	Yaw shaft cover	1	011	blades nut	6
004	insulator	1	012	tail screw	1
005	Yaw shaft bolt	4	013	Hex key	2
006	blades	3	014	manual	1
007	hub	1			
008	blades bolt	6			

6. Assembling module

6-1 Verify the following upon purchase

Tail Unit
 The body Unit and the tail is packed in the same box.
 Optional parts :
 Remote Monitor System

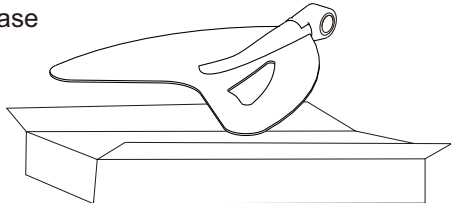

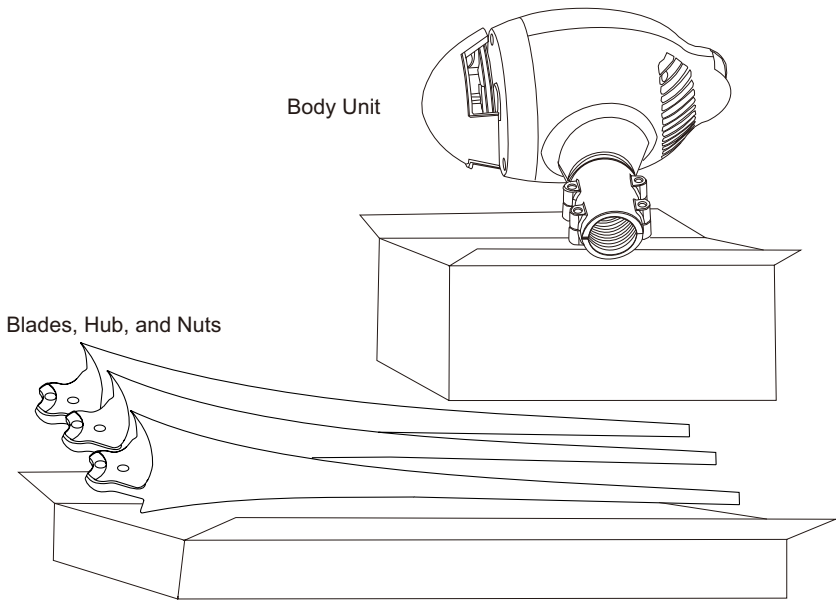

6-2 Assembly procedure

Assembly procedure

- ① Attach the body to the pole
- ② Attach the tail to the body
- ③ Assemble the rotor (assemble the blades to Hub)
- ④ Attach the rotor assembly to the body.

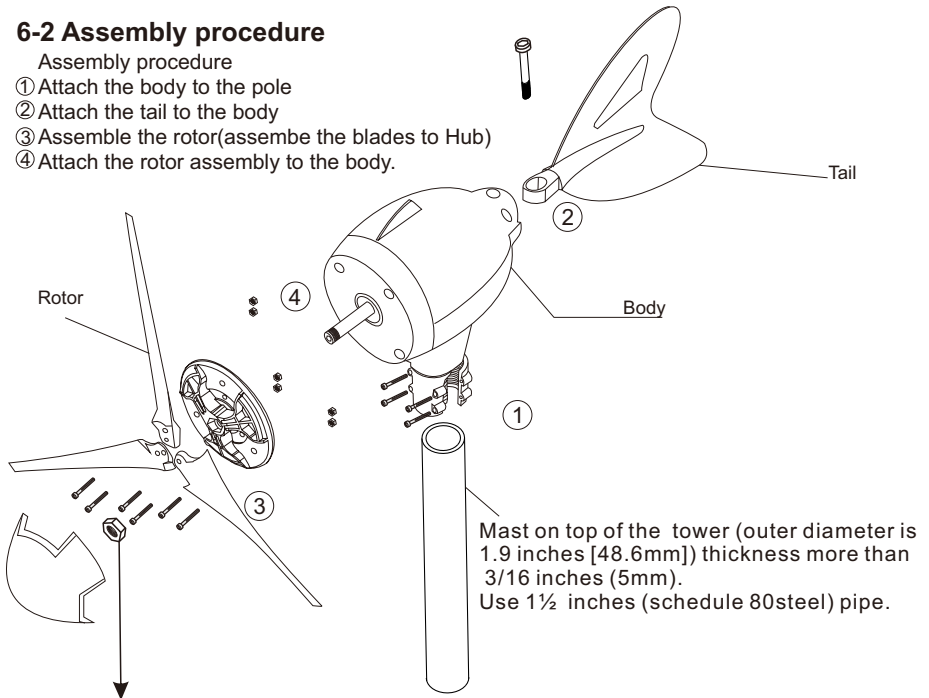

For tightening the main-shaft. Should be able to tighten up to $29.5 \pm 1.5 \text{ft.lb}$ ($40 \pm 2 \text{N.m}$)

NOTE: Do not press the rotor shaft into the body.

WARNING

Failure to observe these safety instructions may result in a severe accident or damage to the wind generator or other parts of the system.

Do not place the wind generator body upside down or inclined during installation or maintenance. Water (rain, snow) can leak inside the body joint gap and cause damage to the turbine. During installation when the body is upside down or inclined and has the possibility of getting wet, put a cover over the body.

- ! On the tower top use a mast with an outer diameter of 1.91 inch(48.6mm), 3/16 inch (5mm) of thickness and at least 3 ft (1m) in length. A 1-1/2 inches schedule 80 steel pipe meets this requirement. Do not use plastic pipes.
- ⊘ Do not install the wind generator if the pole is not standing straight.
- ! If the wind generator is not mounted in an upright position, it could topple or fall, causing injury or damage to the system.
- ⚠ Moving rotor blades are as dangerous as a sharp object. During installation and maintenance, attaching the rotor to the tower body is extremely dangerous because of the of the potential wind that can rotate the rotor and causing a serious accident such as death or injury. After attaching the rotor to the body, fix the rotor in place to prevent it from rotating until the wind turbine has been completely installed.
- ! If the wind turbine has not been completely assembled, a strong gust of wind or similar phenomenon may cause it to fall, causing an injury or other mishaps.

When wind turbine has been completely assembled, in order to prevent corrosion, apply silicone sealant to the screw hole till the screw hole is completely covered.

*Be careful not to apply the silicone sealant to other parts of the body.

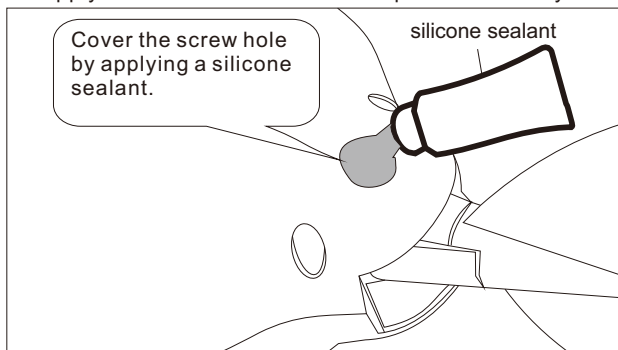

6-3 Attaching to pole

While attaching the wind turbine to the tower, be careful not to pinch the AWG#10 (5.5mm²) yaw wires. Slide the yaw all the way down over the end of pole. After the yaw is seated on the pole, move it back up a 1/8th inch (2mm) to prevent the bottom of the yaw from contacting the top of the pole. This way the only contact between the tower and yaw is through the rubber pad, which will reduce noise transmission. Using a torque wrench, tight all mounting fasteners to 16±0.74ft.lb (22 ±1N.m). Make sure that your tower allows for proper clearance of the blades. A minimum of 2inches (50mm) clearance must be given between the blades tips and any obstructions.

7.Connecting the System

7-1 Before connecting

The 24V or 48V model is used as a standalone system (off-grid system). A 24V or 48V battery is required for the system. The following explains how to connect the wind generator power cable (approximately 20inches [500mm] long) and provides a typical example of a wind turbine system connection.



*Pay attention to the + and – terminals when connecting the power cable to the battery. Reverse connection will cause serious damage. (Be aware that any damage to this product caused by improper connection is NOT covered by the warranty. Connect the cables to the correct terminals).

7-2 Length of the extension cable that leads from the wind generator to the battery

The wind generator is designed to use double wires with a length of 15m (49ft) and a gauge of AWG #8 (8mm²) between the wind generator and the batteries. However you can select the appropriate wire gauge according to the distance. Please check section 9 (“Considerations when choosing Peripheral Materials/Devices”). Make sure to include the height of the tower.



The wind generator has an output voltage of 25V or 50V. Connect either a single 24V or 48V battery, or 2x12V / 2x12V batteries in a serial connection.

7-3 D.P.D.T. (Double pole double throw) blade switch

To ensure safety, the wind generator is equipped with an emergency stop feature (See D.P.D.T diagram). In the event of an emergency stop, the wind generator’s power supply must be shut off for approximately 10 seconds before being restarted. In order to facilitate turning the power on/off, we recommend the installation of a D.P.D.T. BLADES SWITCH between the wind generator and the battery (see next section)

Circuit Diagram of D.P.D.T

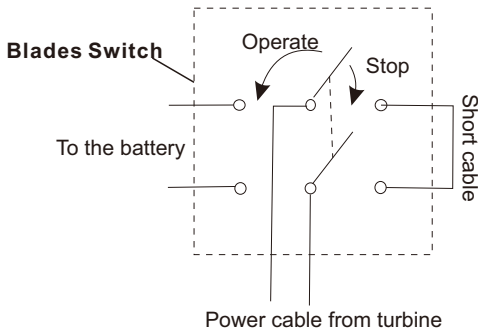

7-4 Connecting the wind generator output cable extension

A total of four power cables extend from the wind generator:

*Each cable is 20 inch(500mm) long. Use a compression sleeve to connect the extension cable that leads to the D.P.D.T. switch. Use electrical tape or a shrink tube to insulate the connections.

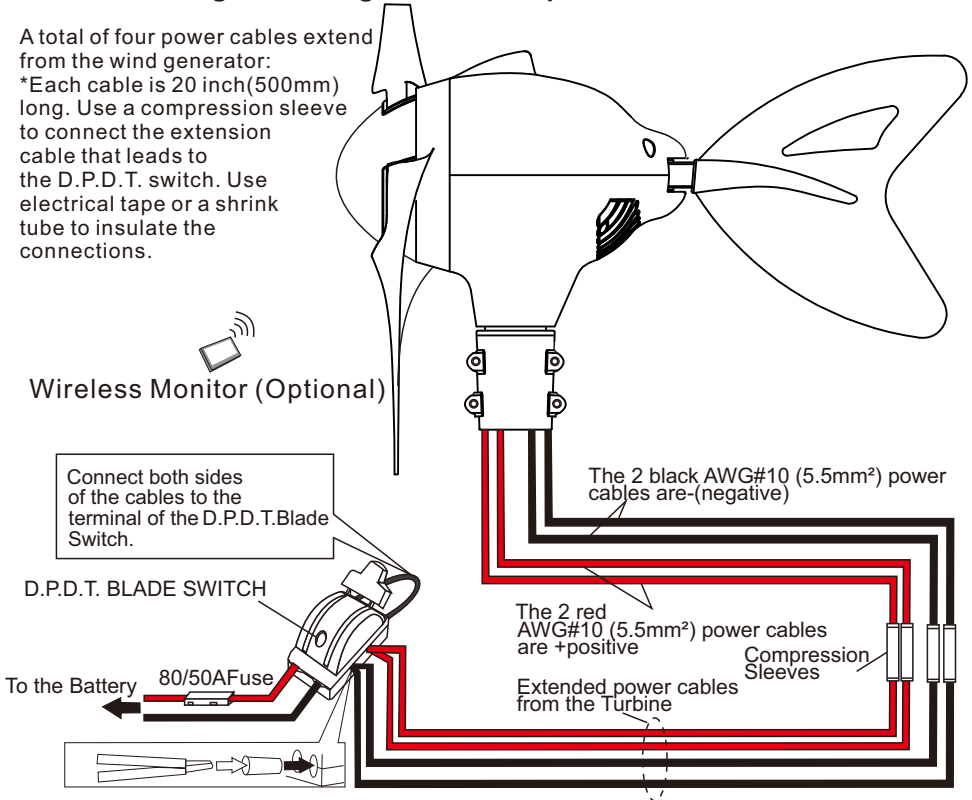

Important

Pay attention to the + and - terminals when connecting the power cable to the battery.

A reverse connection will cause serious damage to the unit.

7-5 Connection example

The wind generator can be used in a multitude of configurations. This section shows a typical connection.

When the wind turbine is not generating power because whatever reason (normal, protection or some miss-connection to the battery bank), the status indicator LED (lamp) remains off.

In this condition, the current to keep running the wind turbine's controller (microprocessor, LED light, etc.) comes from the battery.

This current is insignificant (less than 8 mA).

NOTE: Do not be confused by the spark that can happen on a controller's DC-Output wire, when connecting to the battery or when activating the brake function. This is an instantaneous high current pulse due to the inrush current of the output capacitor inside the turbine. This happens

only when the turbine is first connected to the battery (with the capacitor discharged) or at the moment the charged capacitor is short circuited by the blade switch in the “Brake” position.



This manual is intended for individuals who have the knowledge and technical skills needed to work with batteries and electrical wiring. If the wind generator is used in an inappropriate configuration or wired incorrectly, its use could cause a severe accident and damage the system, including this product.

If you have any questions regarding the wind generator system configuration, contact either the dealer where you purchased this product or Shoot Power Customer Service for more information.

7-6 Connecting the System

You have to connect 4 x 12V batteries in series to get a 48V group. When the 48V groups are connected in parallel the total capacity is the sum of all individual 48V group capacities. Please see batteries sub-section for more details(24V system just need 2x 12V batteries).

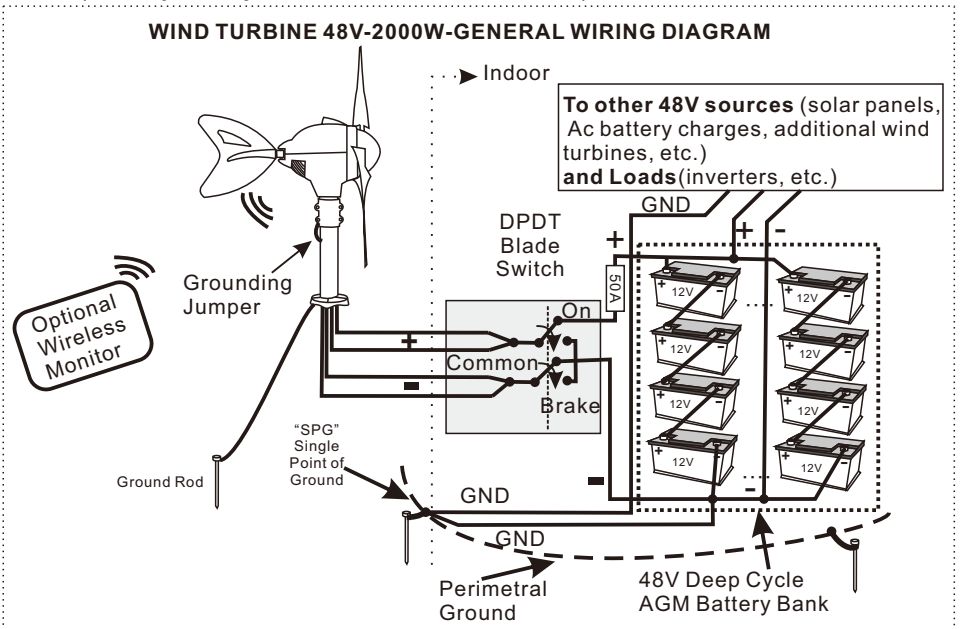

8. Explanation Operations

During operation, the LED indicator on the body of the wind generator can be used to check the operating status of the system.

The indicator LED can light in solid or flashing red, green and orange (red and green).

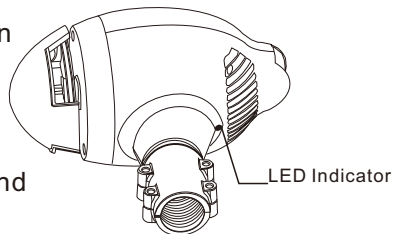

Operating Status Table

Mode	Indicator Light	Status	Cause	Next Operation
Start/Restart	No light	Not generating power. (Wind speed range: 0 to 3 m/s, 0 to 11KPH, 0 to 6.7MPH)	The power is off, or the wind is weak and the rotor is rotating below 420rpm or the DPDT Switch is on brake position.	Starts in normal operating mode
Normal operation	Solid green	Generating power. (Wind speed range: 3 to 12 m/s, 11 to 43KPH, 6.7 to 27MPH)	When the rotor is rotating at 0 to 999 rpm	
	Flashing green	Generating power at controlled rpm. (Wind speed range: 12 to 20 m/s, 43 to 72KPH, 27 to 45MPH)	The rpm is limited to 1000 rpm.	
	Flashing red	Generating power at controlled 600rpm.	Wind speed: Over 20m/s, 72KPH, 45MPH	Recovers to normal operation when wind speed below 20m/s, 72KPH, 45MPH
Voltage protection	Flashing red	Generating power at controlled rpm.	When battery voltage is full and exceeds 57.2V	Recovers to normal operation when the voltage drops below 53.2V
	solid red	Rotor stopped	(24V SYS 28.6V)	(24V SYS 26.6V)
Temperature protection	solid red	Rotor stopped	When the temperature of the alternator cover exceeds 90°C, 194°F or the temperature sensor is damaged	Recovers to normal operation when the temperature drops below 60°C, 140°F, If it is not recovered over one hour, contact us
Other	On and off	Intermittent brake	Defective or loose connection to the battery	Check battery connections, the turbine brushes and their tracks

9. Considerations when choosing Peripheral Materials/Devices

9-1 Batteries

•Type: We recommend the use of deep cycle batteries (particularly AGM) to handle the deep charge/discharge cycles in the wind turbine system. The deep cycle battery has less instant energy than the starting (cranking) ones used on cars, but greater long-term energy delivery. A car battery will not last as long when used for repeated deep charged/ discharged cycles.

•Series/Parallel Connections: You have to connect 4 x 12V batteries in series to get a 48V group (24v system 2x 12V batteries). The batteries in series within a group have to

be the same type, chemical, age and capacity (in Ah). You can connect several 48V groups in parallel to increase the battery bank capacity in Ah. However the capacity of a 48V group is the same of each single battery in series within the group (no Ah increment). Each 48V group can have different capacities. When connected in parallel the total capacity is the sum of all individual 48V group capacities(**24V sys need match 24V group**).

- Minimum Battery Bank Capacity in Ah: We recommend 500Ah (420 Ah minimum) when using the 2000W wind turbine as the unique power source. If there are additional 48VDC sources connected to the battery bank (i.e. solar panels, AC-battery chargers, additional wind turbines, etc.) the capacity of the batteries should be increased to avoid exceeding their maximum charging current. As an approximation, the ratio between Total-48VDC-Source-Power / 4 = Minimum recommended battery capacity. For example if there are up to 500W of solar panel power and up to 2000W of the wind turbine power connected to the battery bank, we get $(500+2000) / 4 = 2500/4 = 625 \text{ Ah} = \text{minimum recommended battery bank capacity}$ (**24V system need match concern 24V batteries group**). Please check your batteries specifications.

- Sizing: The size (capacity in Ah) of your battery bank depends on your application. For a specific load, the bigger the battery capacity in Ah, the longer the run time and the charging time.

The charging time for the battery bank depends on its capacity in Ah, the average consumption current of the loads and the average power supplied by the turbine. This average power depends on the average wind speed condition (in MPH) at your location. The higher the average power you get from the turbine the shorter the charging time will be. As a result of that, for a specific charging time, the faster the average wind speed the bigger (in Ah) the battery bank can be.

The wind turbine can supply a power from 0 to 2000W in a wind speed range from 7 to 45 MPH. You can approximate the values in between the range. With this information and using standard battery charging tables/calculators (check the Web), you can get the average charging time. So you can play with all the parameters in order to meet the requirements for your specific application.

9-2 Mounting Tower:

The mounting tower that supports the wind generator is an extremely important part with respect to safety. The mast used to attach the turbine and its foundation, must be strong enough to provide adequate safety.

- Location and height of the mounting tower: select a free and safe location where the ample amount of wind flow is obtained. The height of the pole must be 11.5ft (3.5m) or more to ensure safety from hazard to people.

- The tower must have an upper portion of at least 3ft(1m) in length and an outer diameter of 1.9inches(48.6mm)(the1½inch schedule 80 steel pipe

meets it). The total tower height must be sufficient to prevent accidents with body or structures.

- The tower must withstand horizontal wind pressure of 231lbf(105kgf) (at a wind speed of 49.2m/s, 110mph,177KPH).
- If unsure please consult with your local tower contractor for details.

9-3 Cable Diameter Sizes:

To select the appropriate cables gauge, measure the distance between the turbine and the batteries. Make sure to include the height of the tower. Please refer to the following wire gauge chart.

Distance between the turbine and the DPDT switch	Wire Gauge(2 cables per polarity)			
	Cross Sectional Area	Diameter of the cooper core	AWG #	Maximum Total resistance (round & trip)
Up to 7mm(23ft)	5.5mm ²	2.64mm	10	0.022Ω
Up to 15m(49ft)	8.0mm ²	3.19mm	8	0.03Ω
Up to 30.5m(100ft)	21mm ²	5.19mm	4	0.024Ω
Up to 46m(150ft)	34mm ²	6.6mm	2	0.023Ω

NOTES:

- For the connection between the DPDT switch and the battery bank, you can use the same double wiring per polarity as in the table. Alternatively you can use a single cable AWG #6. In all the cases the cable between the DPDT and the battery bank has to be no more than 3ft long.
- The DPDT blade switch included in the kit allows cables up to AWG # 4 easily. For the AWG # 2, perhaps you need to remove some of the wires at the end of the cable to reduce its diameter or use a proper spade or pin crimp terminal.

9-4 Inverters:

This device is used to convert the DC power from the battery to the standard AC power used at home.

Verify the capacity and type of your inverter to ensure that it is appropriate for the load you are using.

- Always use 48VDC inverters(24V system need match 24V inverters).
- Always use inverters equipped with battery (DC Input) overvoltage protection circuit and battery low voltage (under voltage) disconnect feature.

•Connect the inverter and all other devices directly to the battery bank posts. Never use the same wires of the turbine to connect other DC devices (sources or loads), Each device has to be connected directly to the battery bank posts with its own wires. If the battery bank posts are so crowded with wires, try to use a junction bar on the posts.

9-5 Grounding:

We recommended installing a 1 or 2 ft (30 or 60cm)long grounding jumper between the wind turbine bracket hex bolts and the mast. Use AWG # 6 wires with ring crimp terminals (lugs) . The terminal ring inside diameter should be 3/8 inch or 10 mm. It has to be mounted in between the 2 half-moon brackets and inside one of its 4 hex bolts. Remove the coat of paint on the contact area and use electrical joint compound. The brackets have to be tighten fully, otherwise use stainless steel flat washers to fill the gap. To connect the jumper to the mast pipe, you can use grounding clamps of the same metal as the pipe itself to avoid galvanic corrosion. Connect the base of the tower/mast to earth ground, using enough ground rods, according to the soil conductivity. Try using a single point of ground “SPG” at the entry of the battery room. It should be connected to a ground perimeter that uses ground rods. Connect the battery bank negative and all the indoors units chassis ground to the SPG only, using independent wires.

Since the turbine typically has to be mounted on a structure (tower, pipe, etc.) you should take into account the possibility of a lightning strike in your area that could hit the top of the structure.

Most of the time a lightning ground system super-exceeds the requirements for a safety ground. However be sure always to meet the requirements as per the local electric code in both cases. Consult a certified electrician or technician specialized in both types of grounding systems.

The customer itself or through a professional contractor, has the responsibility to meet the local electric code.

Please check periodically the Shoot Power website for more information about grounding.

10. Site Elevation:

An important fact to keep in mind is elevation. The higher the wind generator is from sea level, the lower the air density. Air density is directly proportional to the output of your wind generator. Here are some general numbers to keep in mind when determine the maximum output that can be expected.

FEET	METER	OUTPUT POWER
1-500ft	0-150m	100%
500-1,000ft	150-300m	97%
1,000-2,000ft	300-600m	94%
2,000-3,000ft	600-900m	91%
3,000-4,000ft	900-1,200m	88%
4,000-5,000ft	1,200-1,500m	85%
5,000-6,000ft	1,500-1,800m	82%
6,000-7,000ft	1,800-2,100m	79%
7,000-8,000ft	2,100-2,400m	76%
8,000-9,000ft	2,400-2,700m	73%
9,000-10,000ft	2,700-3,000m	70%

11. Maintaining the generator system

Monthly/ Yearly Inspection:

Although the wind generator is basically a maintenance-free system, we recommend visual inspections (see details on the operating status table).

- a) Is the system exhibiting operations listed on the “Operating Status Table For example: the indicator lamp is green when the rotor is rotating at a high speed(250-1000rpm), etc.
- b) Are the blades free from damage?
- c) Is there an approximate 3mm gap between the aluminum hub and the front unit face?
- d) Is any debris such as ice, snow, or tree branches jamming the turbines?
- e) Is the joint on the tail moving smoothly?
- f) Is the tail free from any minor damage?



WARNING



CAUTION



If replacement is necessary, only use parts specified by Shoot Power. Use other parts could cause accidents or malfunction.



When strong winds blow, tree branches and other objects may make contact with and damage the wind turbine, its support pole, or its wiring. Continued use of the wind turbine when it is damaged may cause electric shock, a serious accident, or cause the turbine to cease functioning. Inspect all parts of the wind turbine after periods of strong wind.

Do not place the wind generator body upside down or inclined during installation or maintenance. Water (rain, snow) can leak inside from the joint gap of the body and may cause damage to the turbine. When the body is upside down or inclined and have a possibility of getting wet, put a cover over the body to avoid water.

12. Troubleshooting

Problem	Symptom	Solution
Insufficient charging current to the battery bank when the rotor is running	Insufficient wind speed, below the start-up one (11 KPH, 7 MPH)	Wait for better wind speed condition
	Rotor and/or yaw bearings within the break-in period	They requires about 60-100 hrs. of operation in normal wind speed (18-20 MPH) before they are running at peak efficiency
	Rotor shaft gets stuck and rotates with difficulty	Rotor bearings damaged (rusted or with dust). The bearings need to be replaced
		Stator and rotor touching together because of excessive bearing waste. The bearings need to be replaced
	Consistent air turbulence condition (1)	Change the location and/or increase the height of the tower/ mast. Make sure to install the turbine 25 ft. (7.6 m) on open ground or 20 ft. (6m) above nearby obstructions
	The yaw is not moving 360° freely so the turbine is not pointing toward the wind direction	Rotor bearing damaged (rusted or with dust). The bearing needs to be replaced.
		The pole/mast is not standing straight up. It needs to be in a perfect vertical position
Generating power at controlled rpm	This is normal when the wind speed and/or the battery bank voltage are close to their highest limits. For more details see the Indicator Light on the operating status table. The unit will resume normal rpm operation in an automatic and unattended way.	

The turbine (especially its tail) is yawing continuously	Swirling air because of turbulence	Change the location and/or increase the height of the tower/mast. Same as per (1) above.
Every time the rotor shaft begins to spin, it stops suddenly with a strong brake action	Open circuit in the DC connection between the turbine and the battery bank	Check for loose or open connections in the cables. Make sure the DPDT blade switch is in the ON position (neither the open nor the brake [short circuit] one).
The rotor remains stopped even with high wind speed condition	If the Indicator light is solid red	The battery bank voltage and/or the internal temperature of the turbine have reached their highest (cut-out) limit and the turbine stops. The turbine will resume normal operation in an automatic and unattended way. Wait for the proper cut-in threshold or reset the unit disconnecting and reconnecting the battery voltage with the DPDT switch
	If the Indicator light is off	Make sure the DPDT switch is not in the Brake (short circuit) position
		There is some mechanical problem (rotor shaft bearings, hub, internal stator and rotor contact, internal damage). The unit has to be inspected
The turbine works at controlled rpm often, with the battery bank voltage below the normal maximum of 57.2 V (24V system 28.6V)	The Indicator Light status is flashing red	Normal if within the $\pm 7\%$ of tolerance in the battery voltage threshold values shown in the Operating Status Table.
		Excessive voltage drop through the cables and/or related connectors. Please check the proper cable gauge vs. length as per the cable gauge chart, the related connectors and the batteries' posts
		High resistance or loose connection in the turbine's brushes and/or their tracks. They should be inspected and cleaned.

The battery bank voltage increases easily and fast, forcing the unit to activate the controlled rpm mode and even the complete stop very often	The Indicator Light status is flashing red (controlled rpm mode of operation)	Normal if the battery bank is full charged and there is not/ low power consumption from the loads connected to the battery bank.
	The Indicator Light status is solid red (rotor stopped because of over voltage of 57.2V) (24V system 28.6V)	Battery bank capacity in Ah lower than the recommended absolute minimum of 420Ah
		Battery bank capacity in Ah extremely lower than the recommended absolute minimum of 420Ah, or some damage in the batteries (open cells)
Persistent over voltage in the battery bank (24V system match 24V battery bank)	The Indicator Light status is solid red (Rotor stopped)	Additional 48V source (solar panel, battery charger, etc.) connected to the battery bank without any voltage regulation. Check it out and if so, disconnect it to isolate the problem

13. Warranty Information

Shoot Power Wind Turbines are warranted for a 3 year period. Against defective parts or manufacturers workmanship.

What is NOT Covered

- Damage from lightening
- Damage due to extreme winds
- Damage from improper installation (Including poor tower design and inverted hanging)
- Damage from improper wiring
- Damage to blades from debris and wind blown debris

Any and All modifications to the unit, not stated in this manual

No one has the authority to add to or vary this limited warranty, or to create any other obligations in connection to Shoot Power and its products. Any implied warranty is limited to the duration that is stated on this manual. Shoot Power will not be liable for damages that any person or property might suffer as a result to the breach and or implied warranty. This warranty applies to the original purchaser.



SHOOTPOWER

Made In China

For more information and questions please contact:

Shoot Power Equipment Co., Ltd

INFO@SHOOTPOWER.COM